

液控換向閥 Pilot Operated Directional Valves

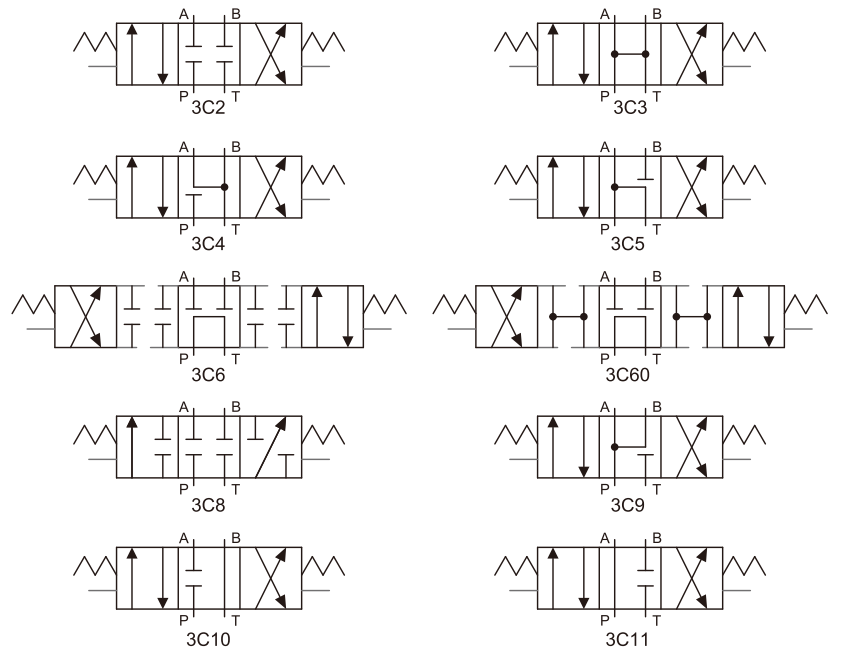

選購指南 HOW TO ORDER

| DS - 04G - 3C2 - D - D - 10 | | | | | |
|-----------------------------|--|--|---|---|-----------------------------|
| 系列編號 SERIES NUMBER | 閥口徑 VALVE SIZE | 閥芯 SPOOL | 導壓方式 PILOT TYPE | 洩油方式 DRAIN TYPE | 設計號 DESIGN NUMBER |
| DS | - 04G : 1/2" (座墊式) Sub-plated Type | - 3※2、3※2、3※4、3※4 3※6、3※6、3※60、3※60……等 (詳見迴路種類圖) See Circuit Diagram Types | - D : 外部導壓 External Pilot - NONE : 內部導壓 Internal Pilot | - D : 外部洩油 External Drain - NONE : 內部洩油 Internal Drain | - 10 (標準型) Standard Type |
| | - 06G : 3/4" (座墊式) Sub-plated Type | 3 C 2 <ul style="list-style-type: none"> 閥芯種類 Spool Type 閥芯彈簧布置 Spool-Spring Arrangement B/C: 彈簧式 Spring Centred D: 珠子式 No-Spring Detented 位置數 Position Number 2: 二位置 2 Position 3: 三位置 3 Position | | | |
| | - 10G : 1-1/4" (座墊式) Sub-plated Type | | | | |

規格說明 SPECIFICATIONS

| 型式 Model Series | 最高使用壓力 Max. Operated Pressure (bar) | 最高切換頻率 Max. Conversion Frequency | 重量 Weight (kg) |
|--------------------|--|-------------------------------------|-------------------|
| DS-04G | 210 | 120 | 6 |
| DS-06G | | | 12 |
| DS-10G | | | 19.5 |

安裝螺絲 MOUNTING BOLTS

| 型式 Model Series | 安裝螺絲 Mounting Cap Screw |
|-----------------|--|
| DS-04G | M 6 X 45 L 2pcs / M 10 X 45 L 2pcs |
| DS-06G | M 12 X 45 L 6pcs |
| DS-10G | M 20 X 75 L 6pcs |

液控換向閥 Pilot Operated Directional Valves

- 內控內洩型 : DS-04G-※※※
內部導壓-內部洩油

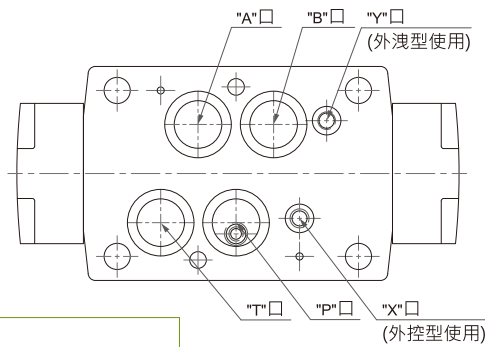
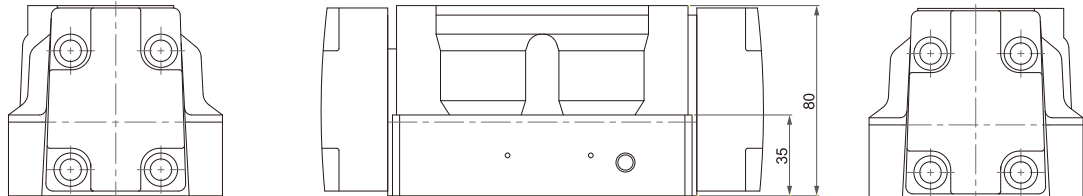
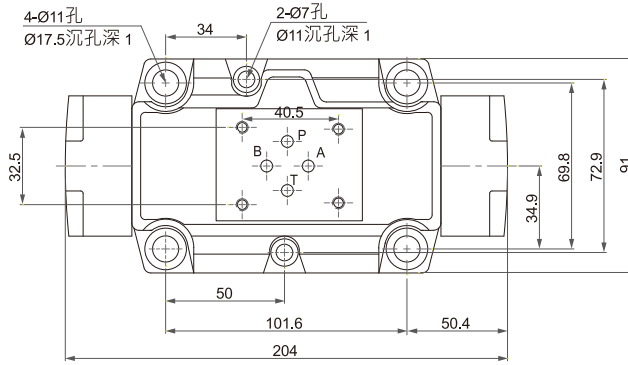

- 外控外洩型 : DS-04G-※※※-PD
外部導壓-外部洩油

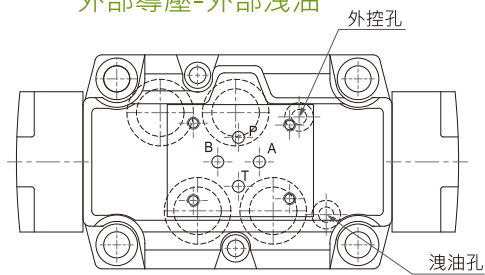

- 外控型 : DS-04G-※※※-P
外部導壓-內部洩油

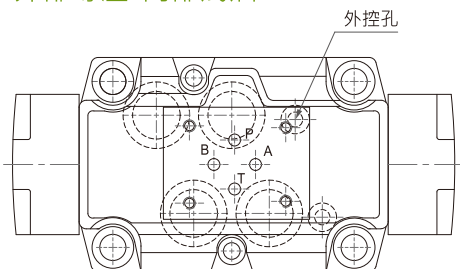

- 外洩型 : DS-04G-※※※-D
內部導壓-外部洩油

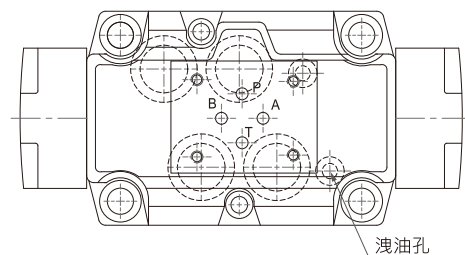

液控換向閥 Pilot Operated Directional Valves

- 內控內洩型 : DS-06G-※※※
內部導壓-內部洩油

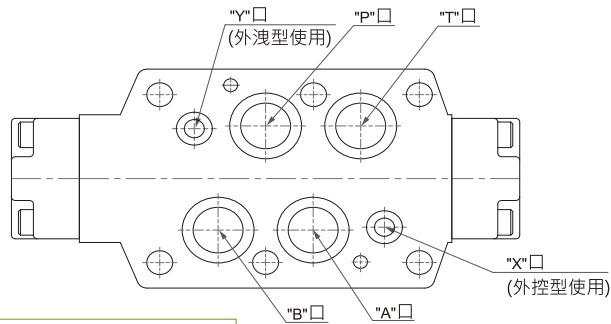
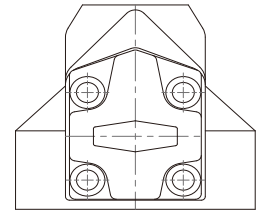
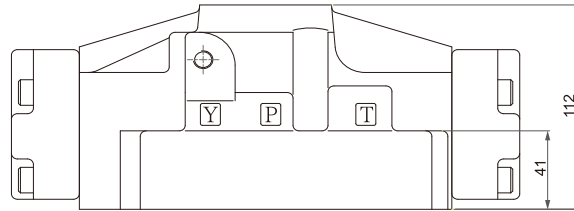
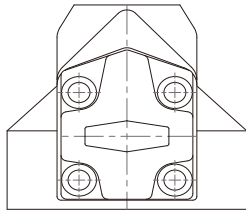
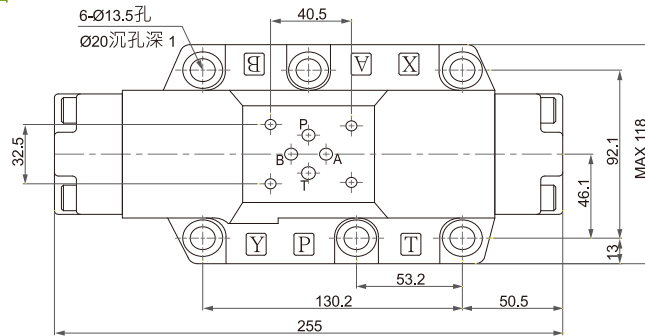

- 外控外洩型 : DS-06G-※※※-PD
外部導壓-外部洩油

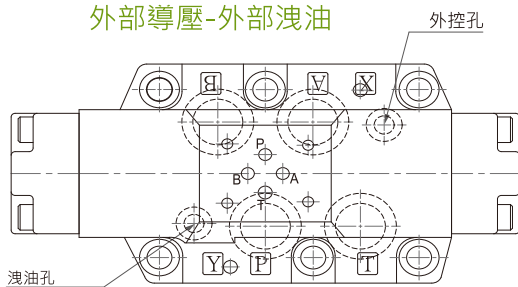

- 外控型 : DS-06G-※※※-P
外部導壓-內部洩油

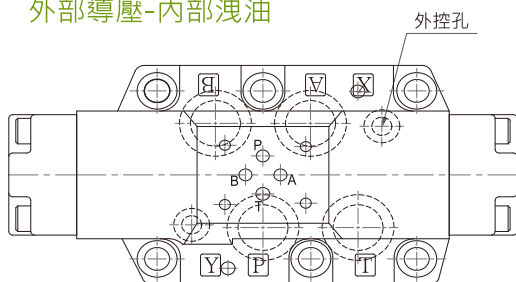

- 外洩型 : DS-06G-※※※-D
內部導壓-外部洩油

